

ZUNDA GASGRILL MGG-561



Art. Nr.: 30100123













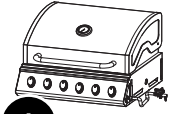



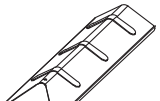
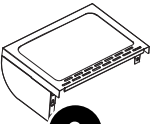

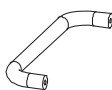

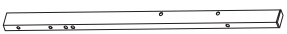





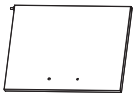
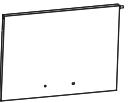

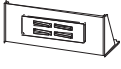
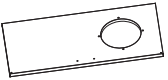
ZUNDA
GASGRILL

- DE** GASGRILL Montageanleitung
- EN** GAS GRILL Assembly Instructions
- FR** BARBECUE À GAZ Guide de montage
- ESP** BARBACOA DE GAS Instrucciones de Montaje
- IT** BARBECUE A GAS Istruzioni di Montaggio



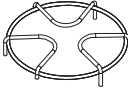

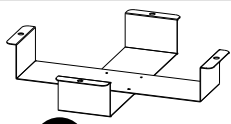











GASGRILL • GAS GRILL • BARBECUE À GAZ
BARBACOA DE GAS • BARBECUE A GAS

**GELIEFERTE EINZELTEILE • DELIVERED ITEMS • PIÈCES LIVRÉES • ARTÍCULOS SUMINISTRADOS
COMPONENTI FORNITI**

 1 1 pcs	 2 1 pcs	 3 2 pcs	 4 3 pcs
 5 6 pcs	 6 1 pcs	 7 1 pcs	 8 1 pcs
 9 4 pcs	 10 1 pcs	 11 1 pcs	 12 1 pcs
 13 1 pcs	 14 2 pcs	 15 1 pcs	 16 1 pcs
 17 1 pcs	 18 2 pcs	 19 1 pcs	 20 1 pcs
 21 1 pcs	 22 2 pcs	 23 2 pcs	 24 1 pcs
 25 1 pcs	 26 1 pcs	 27 1 pcs	 28 1 pcs
 29 1 pcs	 30 1 pcs		

**GELIEFERTE EINZELTEILE • DELIVERED ITEMS • PIÈCES LIVRÉES • ARTÍCULOS SUMINISTRADOS
COMPONENTI FORNITI**

 A M5-8 2 pcs	 B D5 2 pcs	 C D5 2 pcs	 D M5 2 pcs
 E M6-12 30 pcs	 F M8 2 pcs	 G M4-5 4 pcs	 H D4 4 pcs
 I D4 4 pcs	 J M6-50 8 pcs	 K M5 2 pcs	 L M4 4 pcs
 M M6 4 pcs	 N M4-8 6 pcs		

MONTAGEANLEITUNG • ASSEMBLY INSTRUCTIONS • GUIDE DE MONTAGE • INSTRUCCIONES DE MONTAJE • ISTRUZIONI DI MONTAGGIO

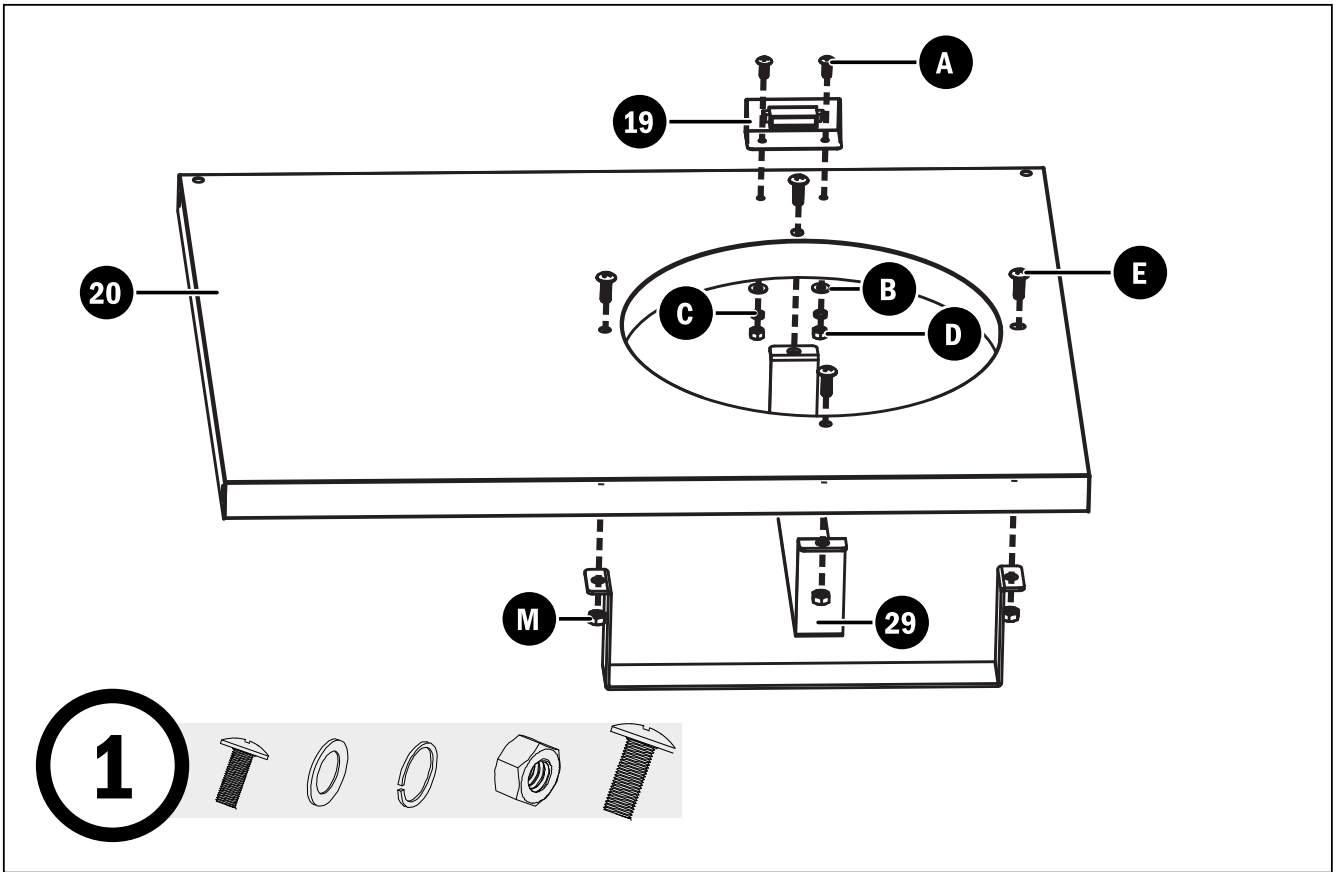

ACHTUNG! Ziehen Sie die oberen Schrauben des Unterwagens erst nach Schritt 7 fest um einen geraden Aufbau des Grills zu gewährleisten.

ATTENTION! Please tighten the upper screws of the carriage after step 7 to ensure a straight structure of the grill.

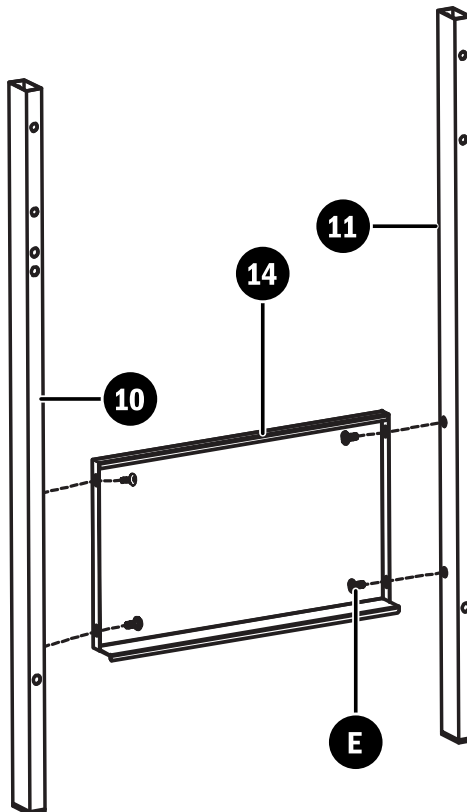

ATTENZIONE! Serrare le viti superiori del carrello soltanto dopo la fase 7, al fine di garantire un montaggio adeguato del barbecue.

ATTENTION ! Ne serrez les vis supérieures du chariot inférieur qu'après l'étape 7 pour assurer la stabilité du barbecue.

¡ATENCIÓN! Con el fin de garantizar el montaje adecuado de la barbacoa, apriete firmemente el tornillo superior del carro después del paso 7.



MONTAGEANLEITUNG • ASSEMBLY INSTRUCTIONS • GUIDE DE MONTAGE • INSTRUCCIONES DE MONTAJE • ISTRUZIONI DI MONTAGGIO

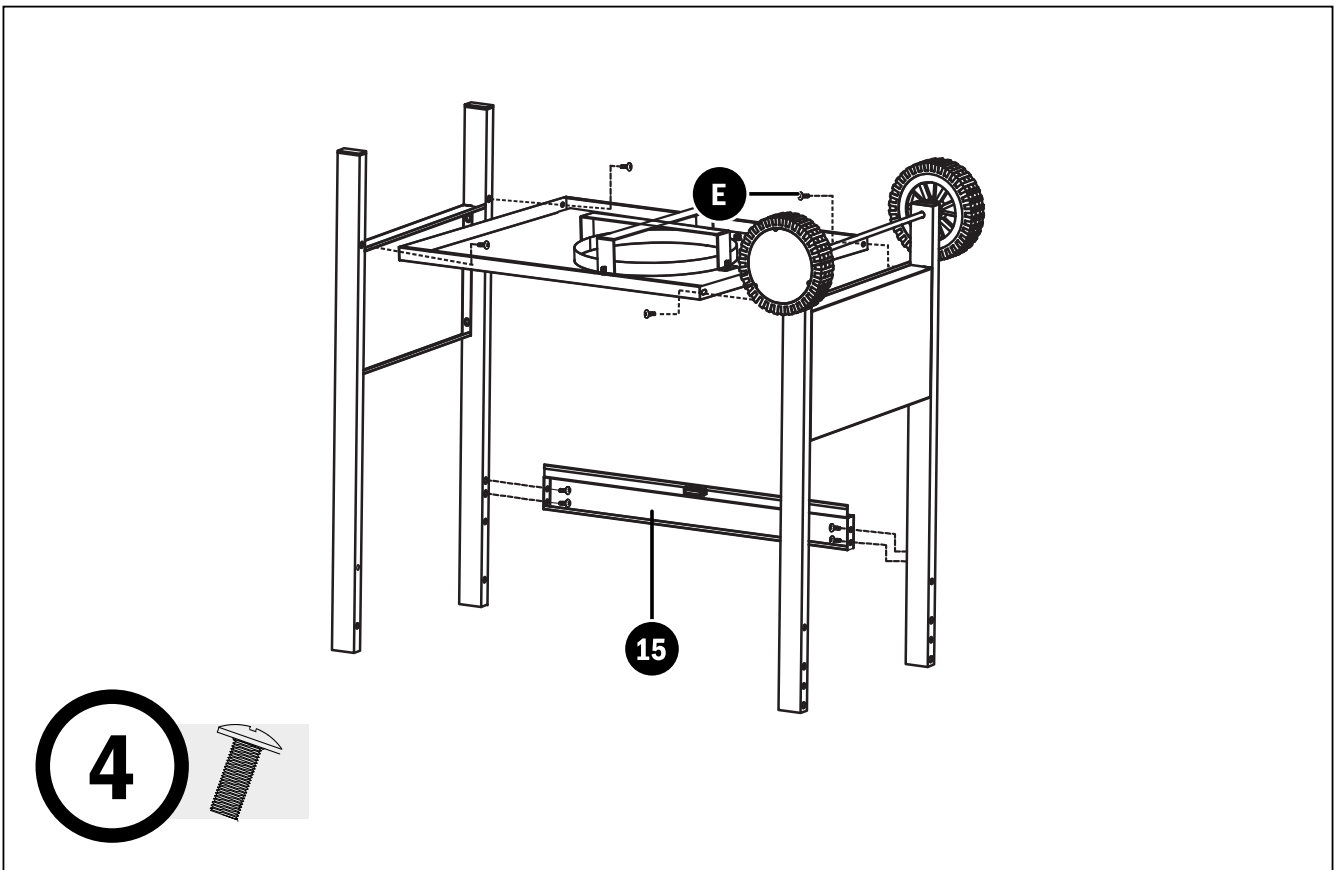
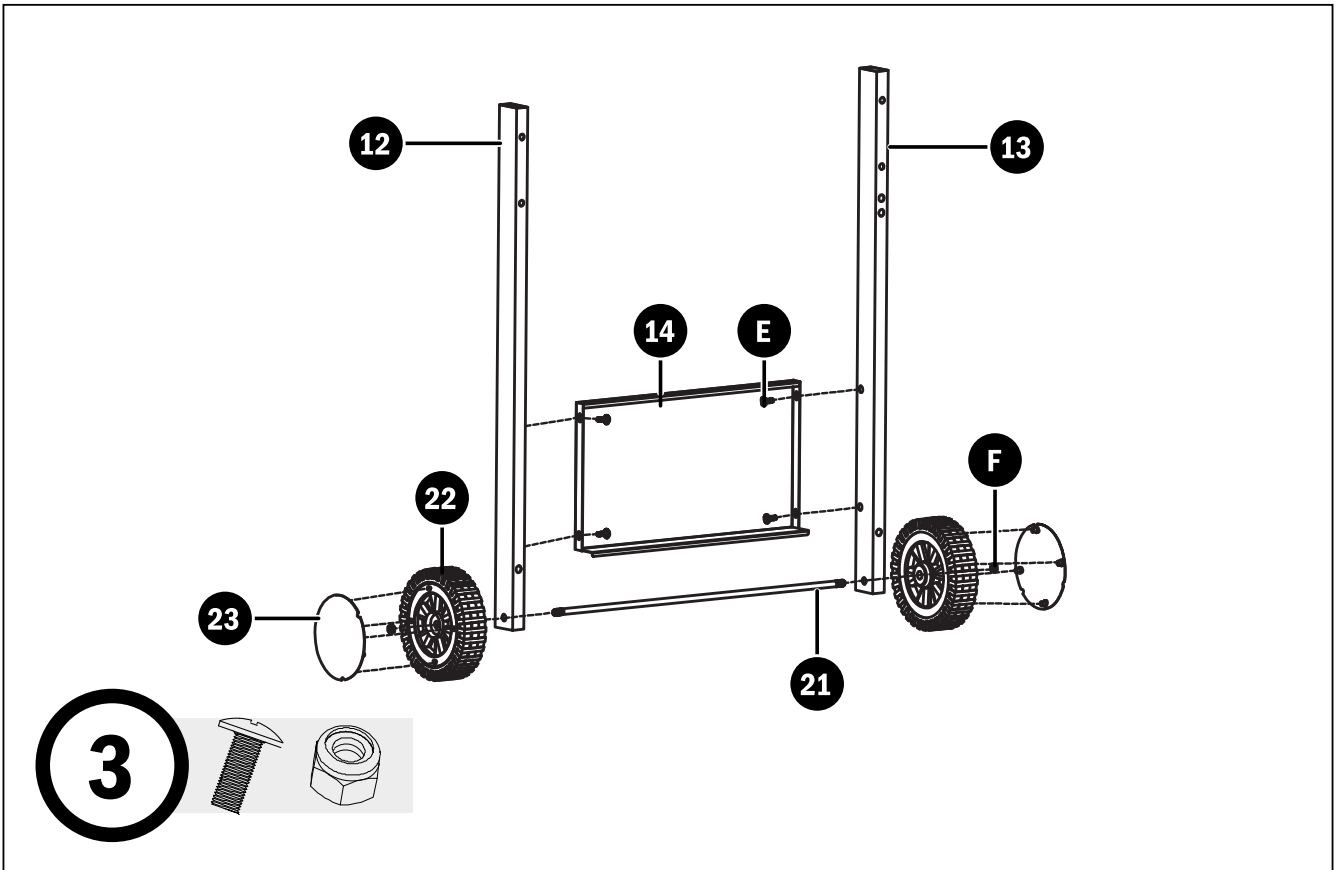

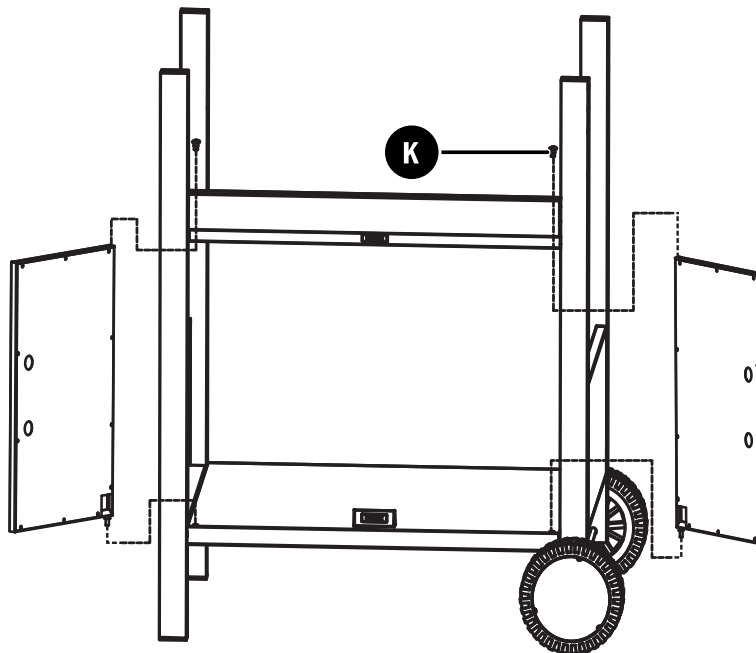
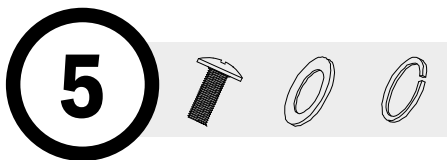
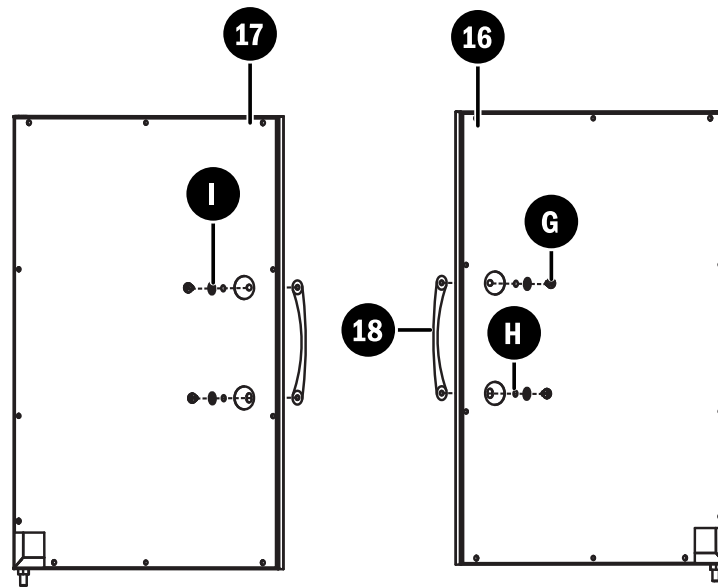

MONTAGEANLEITUNG • ASSEMBLY INSTRUCTIONS • GUIDE DE MONTAGE • INSTRUCCIONES DE MONTAJE • ISTRUZIONI DI MONTAGGIO

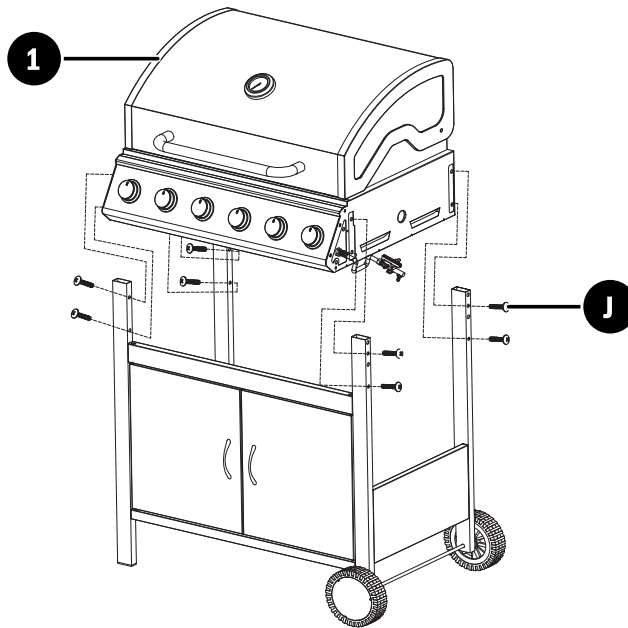

Ziehen Sie nun die oberen Schrauben des Unterwagens fest.

Tighten the upper screws of the carriage.

Maintenant, serrez les vis supérieures du chariot inférieur.

Ahora apriete los tornillos de la parte superior del carro.

Serrare adesso le viti superiori del carrello.

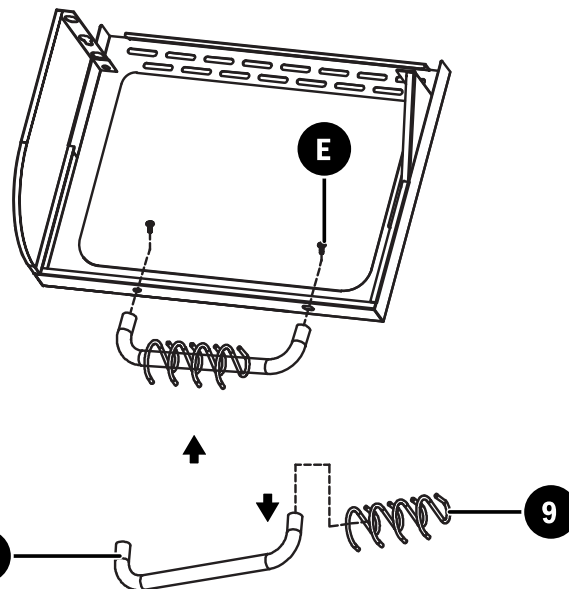

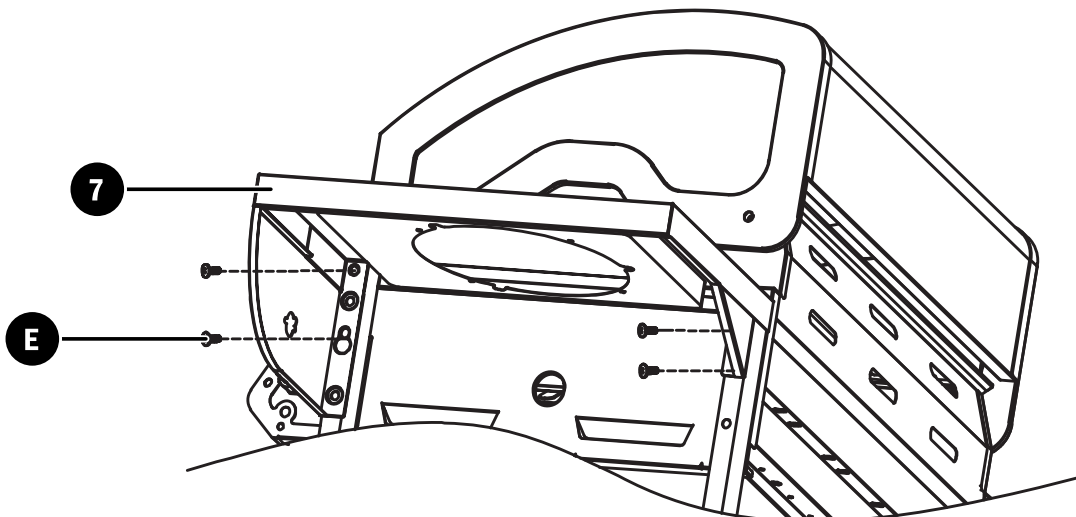
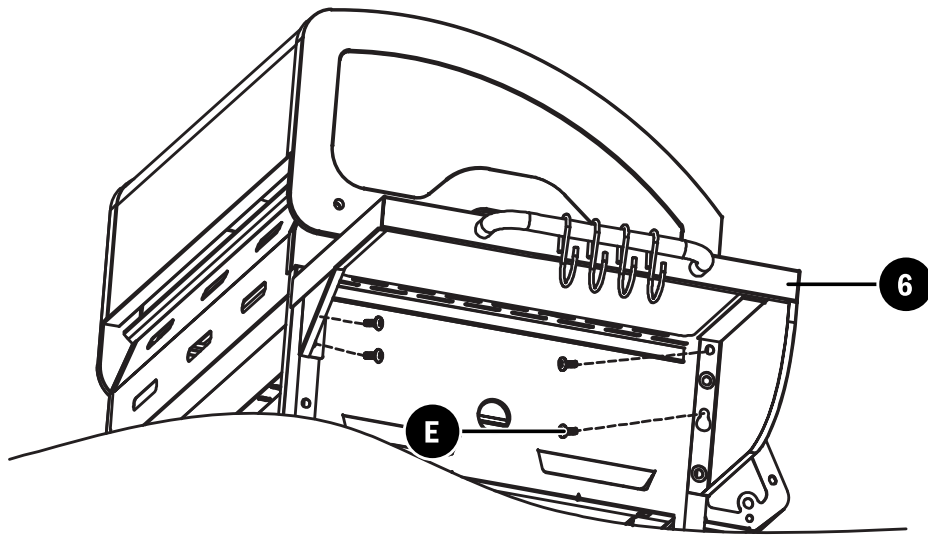

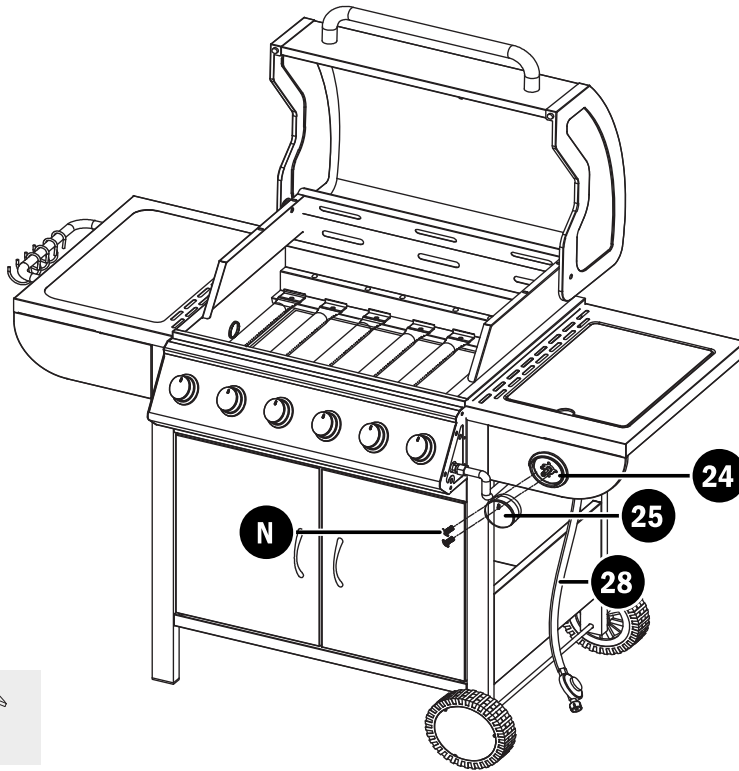

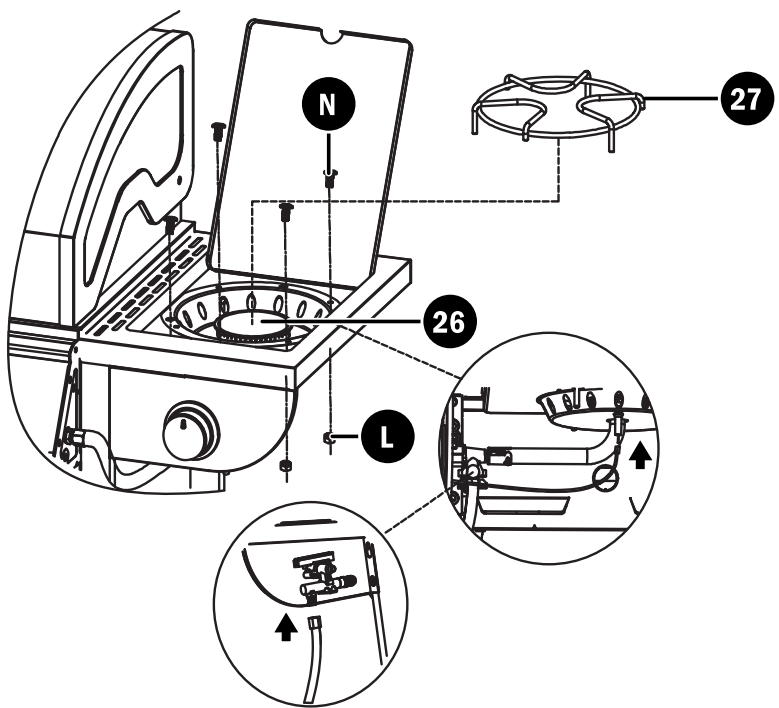

11 



12  

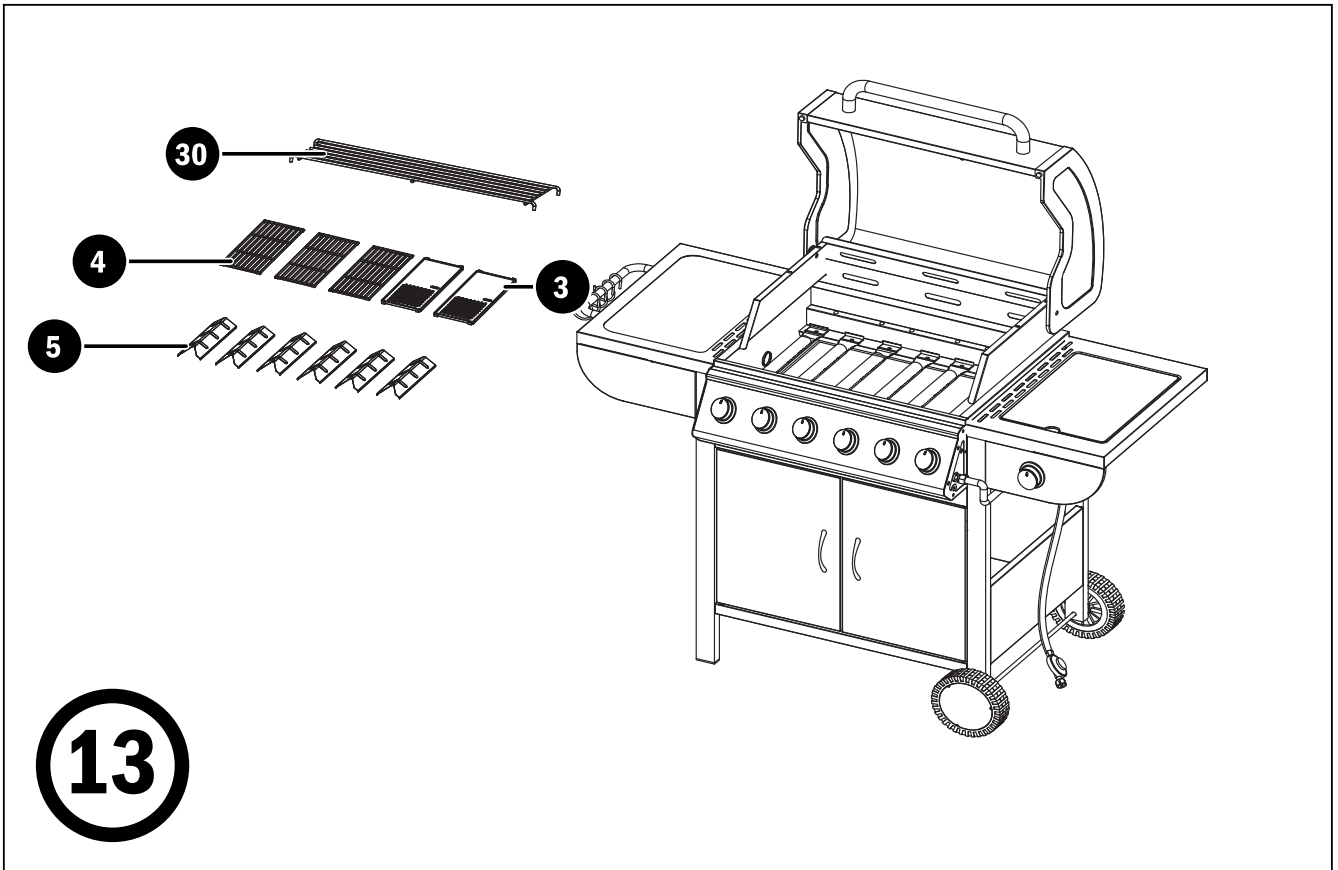

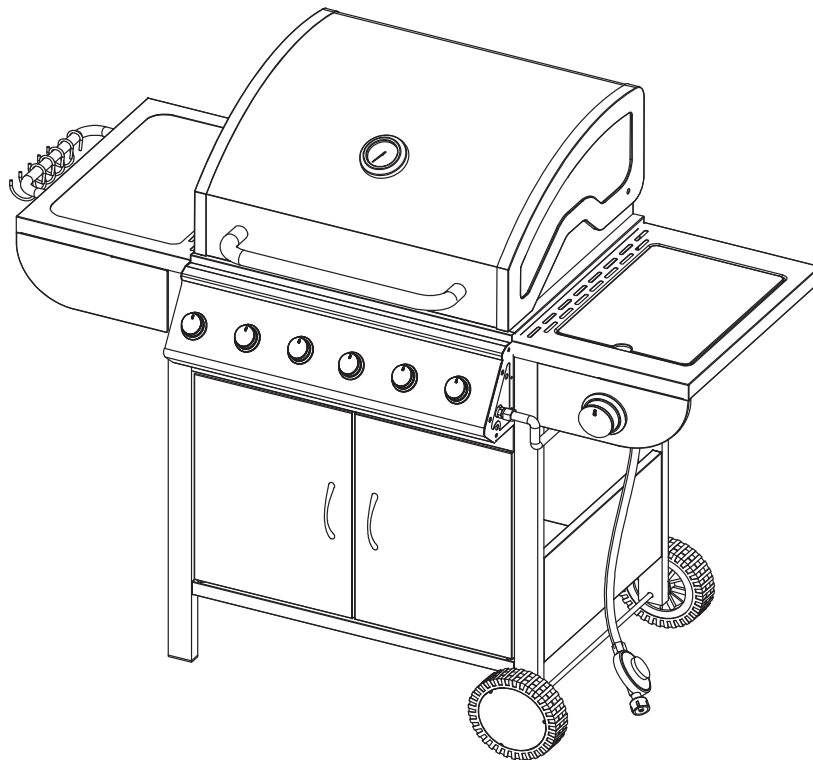

NUTZUNGSBESTIMMUNGEN • CONDITIONS OF USE • CONDITIONS D'UTILISATION • CONDICIONES DE USO • NORME D'USO

COUNTRY OF DESTINATION	APPLIANCE CATEGORY	GAS AND SUPPLY PRESSURE	TOTAL NOMINAL HEAT INPUTS (HS)
BE CH CZ ES FR GB IE IT PT SI	I 3+(28-30/37)	Butane (G30) 28-30 mbar Propane (G31) 37 mbar	19.3 kW 1404g/h 19.3 kW 1385g/h
CZ DE DK FI GB IT NL NO RO SE SI	I 3B/P(30)	Butane/Propane 30 mbar	19.3 kW 1385/h
AT CH DE CZ	I 3B/P(50)	Butane/Propane 50 mbar	19.3 kW 1385g/h
PL	I 3B/P(37)	Butane/Propane 37 mbar	19.3 kW 1385g/h

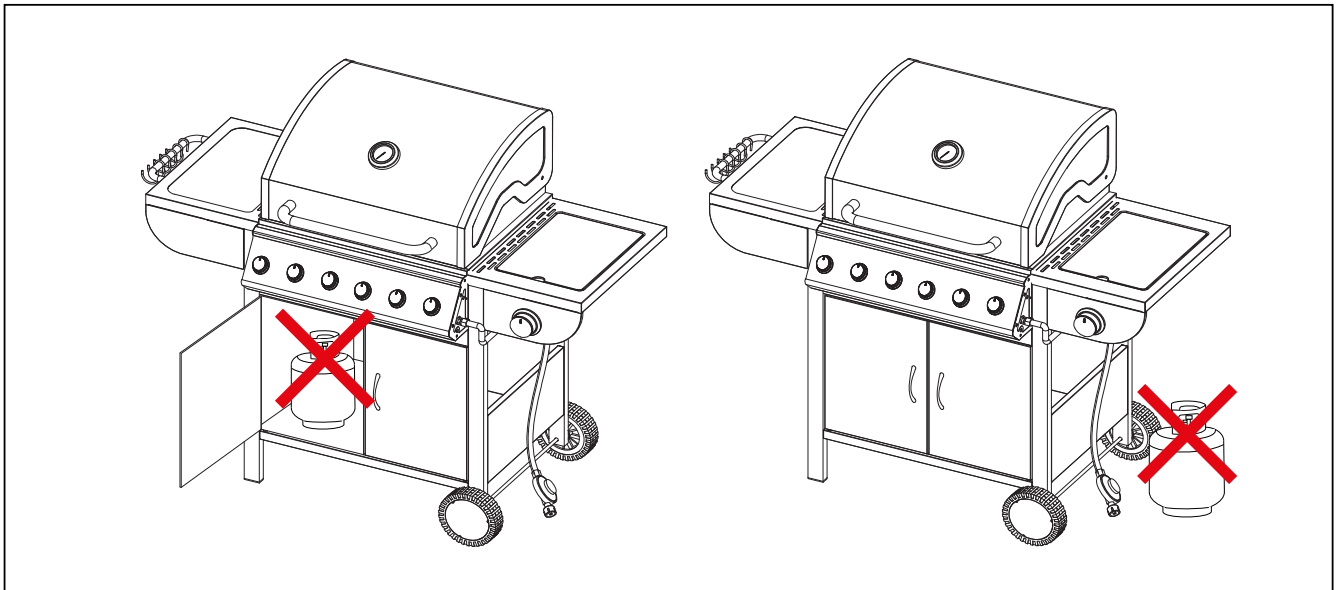

⚠ VORSICHT!

Der Gasgrill ist für den Gebrauch mit einer Gasflasche von 5 kg vorgesehen.
Die Gasflasche darf während des Gebrauchs nicht innerhalb des Geräts platziert werden.
Die Gasflasche darf zum Gebrauch nicht unter dem Seitenbrenner platziert werden.
Verwenden Sie nur Gasflaschen, die den nationalen Sicherheitsbestimmungen entsprechen.

⚠ WARNING!

The appliance is designed for use with gas cylinder 5KGS.
The gas cylinder can not be placed inside the appliance for using.
The gas cylinder can not be placed under the side burner for using
Only use gas bottles that apply to national regulations!

⚠ ATTENTION!

Le gril à gaz est prévu pour une utilisation avec une bouteille à gaz de 5 kg.
La bouteille de gaz ne doit pas être placée à l'intérieur de l'appareil.
La bouteille de gaz ne doit pas être placée sous le brûleur latéral.
Utilisez uniquement les bouteilles de gaz qui respectent les normes de sécurité nationales

⚠ ADVERTENCIA!

La barbacoa a gas está prevista para el uso con una bombona de gas de 5 kg.
La bombona de gas no debe ser colocada para su uso dentro del equipo.
La bombona de gas no debe colocarse para su uso debajo del quemador lateral.
Utilice sólo cilindros de gas que se ajusten a las normativas nacionales de seguridad.

⚠ AVVERTENZA!

Il barbecue a gas è progettato per essere utilizzato con una bombola di gas di 5 kg.
La bombola di gas non deve essere collocata all'interno del dispositivo per essere utilizzata.
La bombola di gas non deve essere collocata sotto al bruciatore laterale per essere utilizzata.
Utilizzare esclusivamente bombole di gas conformi alle normative di sicurezza nazionali.



www.mayergrill.com

Mayer Barbecue®

© 2016 Designed and engineered by Mayer Barbecue

Mayer Barbecue ist eine eingetragene Marke der Schoenberger Germany Enterprises GmbH & Co. KG Zechstr. 1-7, 82069 Hohenschäftlarn